

D4-10
UHF Wide-Band Transceiver

Operator's Manual

Kantronics

RF Data Communications Specialists

1202 E. 23rd Street, Lawrence, Kansas 66046

Order number (913) 842-7745

Service / Technical Support (913) 842-4476

9 am - noon, 2 pm - 5 pm Central Time, Monday-Friday

FAX number (913) 842-2021

BBS number (913) 842-4678 300/1200/2400,N,8,1

5 pm - 8 am Central Time, Monday-Friday; All Day Weekends

We have attempted to make this manual technically and typographically correct as of the date of the current printing. We solicit your comments and/or suggested corrections. Please send to Kantronics Co. Inc., 1202 E. 23rd Street, Lawrence, KS 66046.

Printed in the U.S.A.

© Copyright 1991 by Kantronics Inc., 1202 E. 23rd Street, Lawrence, KS 66046

All rights reserved.

Contents of this publication may not be reproduced in any form without the written permission of the copyright owner.

D4-10, DVR 2-2, KAM, KPC-4, KPC-2, KPC-2400 and KPC-1 are trademarks of Kantronics Co., Inc.

NET/ROM is a registered trademark of SOFTWARE 2000

D4-10 Operator's Manual

Table of Contents

	Page
Introduction	1
FCC Statement	2
Precautions	2
Front Panel Controls and Indicators.....	3
Rear Panel Connectors.....	4
Analog Port DB-9 Connector Detail	4
Power Connector.....	5
TTL Port DB-9 Connector Detail.....	5
Installation	6
Connecting Your Kantronics TNC to the D4-10.....	7
Data Engine	7
KAM/KPC-4	8
KPC-2/KPC-2400	9
KPC-1	10
Connecting Other TNCs to the D4-10	11
AEA PK-232	11
MFJ-1270 or equivalent	12
Operation	13
TXDELAY Settings	14
In Case of Difficulty	15
Disassembly Instructions.....	16
Assembly Instructions.....	16
Ordering Crystals	17
Crystal Specifications.....	17
Installing Crystals and Tuning Up	18
Return/Repair Procedures	20
Warranty.....	20
Specifications	
Parts List	
Parts Layout	
Appendix	
Block Diagram Description of the D4-10	A1
D4-10 Transceiver Specifications	A2
Some Details, the TTL Modulator and Demodulator Plus the Terrestrial/Satellite Option.....	A5

TABLE OF CONTENTS

Introduction

Congratulations and thank you for purchasing the D4-10.

The D4-10 was designed primarily to provide a 10-watt transceiver for high-speed packet operation on the UHF (440 MHz) amateur band. Unique features of the D4-10 are narrow or wide bandwidth reception, narrow or wide transmit deviation settings, fast TR switching, analog and TTL modem interfacing, direct transmit varicap access, direct discriminator access on receive, and receiver-derived carrier detect.

The front panel enables the operator to select one of two crystal controlled channels, narrow or wide bandwidth operation and enable access to the receive local oscillator – for satellite applications. The back panel consists of an analog port (pin for pin compatible with the DVR 2-2), a TTL port, antenna terminal, speaker jack and power connector.

When operated with a Kantronics Data Engine with internal DE19K2/9K6 modem, two plug-and-play modes of operation are possible, 9600 or 19,200 baud packet. When the D4-10 is cabled to the DataEngine-DE19K2/9K6 combination via its TTL port, the system is configured for 19,200 baud operation. When cabled via its analog port 1200, 2400, or 9600 baud are possible using the DE1200, DE2400 or DE19K2/9K6 modems. Both ports of the D4-10 are pin compatible with the DVR 2-2 data port; hence, one cable works for all.

While it is not anticipated that many will use the D4-10 for voice operation, a MIC circuit is included (pin 7 of the analog port only). The mic amplifier does include limiting such that standard narrow-band voice deviation limits are maintained.

In addition, an audio amplifier has been included which you may choose to use to monitor packet reception. An external speaker may be attached at the SPKR jack on the back panel. An internal speaker is not provided. Squelch and volume controls are accessible by removing the "black insert buttons" that are present on the front panel. These are adjustable as desired with a small screwdriver. The squelch potentiometer is to the left and the volume to the right. Detector output for packet reception is unaffected by the volume and squelch settings; they are there only to control speaker action and volume and to set a threshold for FM carrier detection.

In most cases data carrier detect will be derived within the modem you chose to use in conjunction with the transceiver. For example, the DE19K2/9K6 modem derives its own data carrier detect from the received data stream. Additionally all Kantronics TNCs, for packet operation, can be set to derived data carrier detect via firmware. No external DCD kit is required or recommended. For those situations where you find the transceiver-derived carrier detect to be useful, you'll want to leave access open to the squelch potentiometer.

Unless otherwise specified, a D4-10 is shipped from the factory with channel one set for 430.55 MHz. Kantronics shall maintain a few additional crystals for those channels that become popular. The ARRL bandplan calls for nine 100 KHz channels from 430.05 through 430.95 MHz. Part 97 of the FCC rules indicates 100 KHz channels are allowable anywhere in the 440 MHz band. (FCC 97.69 (c) (2) (ii): 100 KHz on frequencies between 220 and 902 MHz.) Common sense suggests that one should check with the local frequency coordinator before installing a wide bandwidth transceiver in operation, particularly in a crowded area.

FCC Statement

This unit has been tested and found to comply with Part 15 of the Federal Communications Commission Rules in effect as of the date of manufacture. If you utilize cables other than those provided with the unit, make sure they are adequately shielded.

Precautions

Please read this operating manual carefully before placing the transceiver in service.

Before connecting the radio to your power supply, be sure you have your supply properly grounded. Connecting the unit to a DC voltage source in excess of 13.8 volts may result in damage to the unit.

Front Panel Controls and Indicators

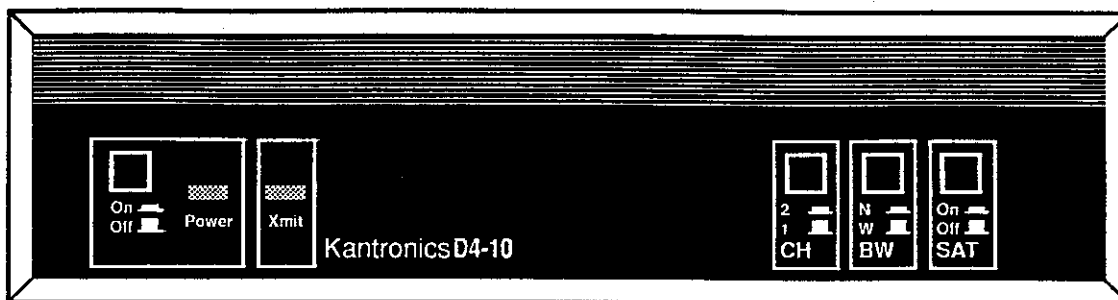

1. Power ON/OFF switch. This is a push-push switch which applies power to your transceiver. When IN power is applied.
2. Power (green) LED. This LED will illuminate when the D4-10 is powered on.
3. Xmit (red) LED. This LED will illuminate when the unit is transmitting.
4. Squelch control. While not normally used in data modes, you can gain access to this potentiometer by removing the "black panel button". Adjustment affects only speaker or FM carrier detect operation; it does not affect data reception.
5. Volume control. While not normally used in data modes, you can gain access to this potentiometer by removing the "button". Adjustment affects external speaker volume only.
6. Channel selection switch. This push-push switch selects which crystal pair is used for transmission and reception. Transmit and receive operational frequencies need not be the same. Channel one is selected when the switch is OUT.
7. Bandwidth selection. This push-push switch selects narrow or wide bandwidth reception. In the narrow position, with the switch in, a standard 455 KHz ceramic filter is selected for the last IF. When out, a six-pole, 60 KHz, discrete linear-phase filter is selected. This filter is used to receive wide bandwidth packet signals such as the 19,200 baud direct frequency shift keying (DFSK) signal coming from another D4-10.
8. Satellite selection. This push-push switch enables a DC control voltage to gain access to the receive local oscillator varicap. This may be useful for future applications and for those modems that wish to adapt to satellite doppler-shift conditions.

Rear Panel Connectors

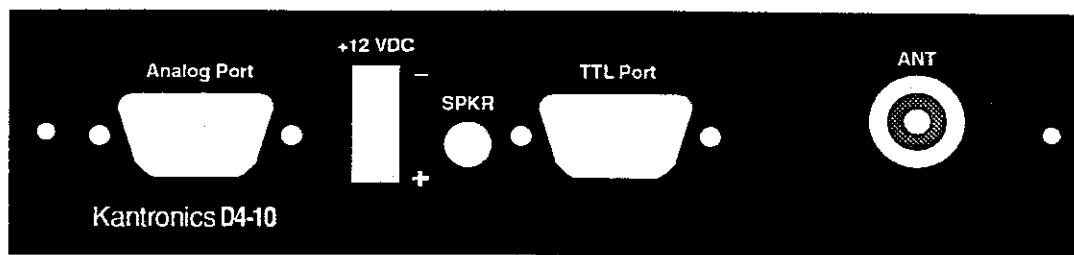

1. Analog Port – DB-9 connector. This connector is for direct connection of all required signals to/from your TNC. The signals of this port are DVR 2-2 compatible.
2. +12VDC – Power connector. This is a two-pin molex connector. Note that the positive lead is at the bottom. See specs for current draw.
3. SPKR. This 3.5 mm jack is for attaching an external 8-ohm speaker. The circuit drives 1/2-watt audio.
4. TTL Port – DB-9 connector. This connector is for direct connection of all required signals to/from your TNC, but expects TXD, RXD and PTT signals to have TTL levels. This port is designed for direct connection, for example, to a Data Engine with the DE19K2/9K6 modem set for 19,200 baud.
5. ANT – antenna. This antenna jack is a BNC. A 50-ohm antenna system is required.

Analog Port DB-9 Connector Detail

Pin 1. Data Input, "TXA". This connection accepts the input from your TNC to be transmitted over the radio. This could be an AFSK signal for slow-speed packet or a DFSK signal for 9600 baud packet. The RXA signal is buffered and then directly drives the varicap for modulation.



Female (Looking at Holes)

Pin 2. Carrier Detect, "CD". This pin provides an active low (ground) when a signal is present on frequency.

Pin 3. Push-to-Talk, "PTTA". Applying a ground to this pin causes the radio to transmit.

Pin 4. Unused at this time.

Pin 5. Unsquelled Audio Output, "RXA". This pin is the direct detector (discriminator) output, providing audio to your TNC. This audio has not been processed (it is unsquelled and unshaped).

Pin 6. Ground.

Pin 7. MIC input, "MIC IN". This pin accepts the audio from your MIC or TNC to be transmitted. Normally, slow-speed packet of the AFSK variety would be applied to this pin.

Pin 8. Speaker Audio Out. The audio available from this pin has been processed and is affected by the squelch and volume controls (on the pc board). This pin parallels the speaker out jack.

Pin 9. Ground.

4

D4-10

June 13, 1991

© Copyright 1991, Kantronics Co., Inc. All Rights Reserved.
Duplication of this manual without permission
of Kantronics Co., Inc. is prohibited.

Power Connector



1. - Minus voltage. This is connected to the common ground.
2. + Plus voltage. Apply 13.8 VDC to this pin for 10 watts power.

TTL Port DB-9 Connector Detail

The pins of this port directly parallel those of the analog port, except that no MIC connection is made available. All signals interfacing this port must be TTL compatible. This port is intended for 19,200 baud packet operation with the Data Engine and DE19K2/9K6 modem. Alternatively, one could operate this port with a TTL-compatible asynchronous modem or terminal and operate in an ASCII or RTTY mode.

Installation

1. Place your D4-10 in the desired operating location.
2. Connect the D4-10 power cable to a regulated 12V dc supply. (Red lead is positive). **WARNING:** Connecting the power backward will result in a blown fuse inside the D4-10. Do not attempt to open the D4-10 until you have read the disassembly instructions.
3. Connect an antenna to the BNC connector located on the rear panel of the radio. The antenna should present a 50 ohm load to the transceiver. As with all antenna installations, you should follow standard safety precautions including the installation of a high quality lightning arrestor in your antenna line to protect against fire, personal injury or possible damage to the radio.
4. An 8 ohm external speaker may be connected to the 3.5mm jack on the rear panel labeled "SPKR".
5. When using 9600 baud packet or lower speeds; connect your TNC to the D4-10 analog port. See the appropriate instructions for your TNC later in this manual.
6. When using the DE19K2/9K6 modem at 19,200 baud, connect the Data Engine to the TTL port of the radio as indicated in the section on Connecting Your Kantronics TNC to the D4-10.
7. Experimenters should connect to the TTL port of the D4-10 if the modulating signal from their modem supplies TTL levels for transmitted data and expects TTL level signals in return from the D4-10 radio. Other modems should be connected to the analog port of the D4-10.

Connecting Your Kantronics TNC to the D4-10

Data Engine

In order to connect your Data Engine to the D4-10 radio, you must make a cable with the following pins connected:

Signal Name	Data Engine DB-15	D4-10 DB-9
Transmit Data	3	1
Receive Data	2	5
Push-to-talk	1	3
Carrier Detect	8	2
Ground	9	6

This cable will work with any of the Data Engine modems. If you plan to use the DE19K2/9K6 modem, the cable length should be kept as short as possible and should not exceed two feet in length. You should use shielded cable for this connection.

DE1200, DE2400, DE9600 or DE19K2/9K6 set for 9600 baud

Connect the 15 pin end of this cable to the port of the Data Engine with your modem installed, and the 9 pin end of the cable to the ANALOG port of the D4-10 radio.

When using the DE1200 or DE2400 modem, you may select to use EXTERNAL carrier detect, allowing the D4-10 to supply the CD signal. To accomplish this, set the MODEM command in your Data Engine to the appropriate value. (Refer to your Data Engine modem manual for details.) Since you are using unsquelched audio, you must set your modem for no equalization and set the AFSK output level for 50 mv p-p (AFSK jumper in high position).

DE19K2/9K6 modem set for 19,200 baud operation

Connect the 15 pin end of this cable to the port of the Data Engine with your modem installed, and the 9 pin end of the cable to the TTL port of the D4-10 radio.

DB-9 Connector

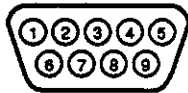

Male (Looking at Pins)



Female (Looking at Holes)

DB-15 Connector



Male (Looking at Pins)

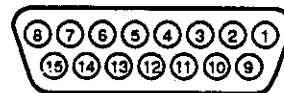

Female (Looking at Holes)

OTHER Kantronics TNCs

The D4-10 was designed to be pin compatible with the VHF port connector on the KAM, and is also pin compatible with the radio ports on the KPC-4, KPC-2, and KPC-2400. Wire the supplied DB-9 connector from the analog port of the D4-10 to your Kantronics TNC using the supplied 5 conductor cable as described below.

KAM/KPC-4

The recommended hookup for the KAM VHF port and the KPC-4 is as follows:

Connect pins 1, 2, 3, 5 and 6 from the selected port (VHF port for the KAM) to the D4-10 DB-9 connector (analog port) on the same pins. This will supply all the required signals for proper operation.

Next you will need to set your TNC for no equalization. This is accomplished by placing the K1 jumper in the KAM so that it connects the center pin of the header with the pin marked 1 on the board. On the KPC-4, you would use jumper K1 for PORT 1 and K2 for PORT 2. These are set for no equalization by connecting the center pin with the pin marked 1 on the board.

You may wish to set the CD command to EXTERNAL, allowing the D4-10 to supply the carrier detect indication from the RF carrier detect. Alternately, you can set the CD command to SOFTWARE and allow the KAM/KPC-4 to detect a carrier by detecting actual data on frequency. NOTE: If you set the CD command to INTERNAL with this wiring, the KAM/KPC-4 will never transmit since the audio input from the radio is unquelled.

Radio Pin Name	D4-10 Pin	KAM/KPC-4 Pin	TNC Pin Name
Data Input	1	1	AFSK Out
Carrier Detect	2	2	XCD
Push-to-Talk	3	3	PTT
Unquelled Audio Out	5	5	Audio Signal
Ground	6	6	Ground

Set TNC jumpers for no equalization
Set AFSK output jumper to HI (50 mv p-p)
Set TNC command: CD EXTERNAL or CD SOFTWARE

NOTE:

Pins 4, 7, and 9 are reserved for future use and should not be connected to your TNC.

DB-9 Connector

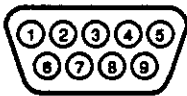

Male (Looking at Pins)



Female (Looking at Holes)

KPC-2/KPC-2400

On the KPC-2/KPC-2400 you should connect pins 1, 2, 3, and 6 from the TNC to the D4-10 DB-9 connector (analog port) on the same pins. The KPC-2 and KPC-2400 will not operate properly with the unsquelched and unshaped audio provided by pin 5 of the D4-10, so you should connect pin 8 of the D4-10 to pin 5 of the KPC-2/KPC-2400. This will provide speaker audio to the input of your TNC, and this audio is affected by the front panel squelch and volume controls.

Now set the equalization to none by using the command EQUALIZE OFF. Connect an external speaker to the external speaker jack on the rear panel of the D4-10, and adjust the squelch control just beyond the point where the open squelch can be heard through an external speaker. If you don't use an external speaker, you can adjust the squelch control to the point where the RCV led on your TNC goes out.

We recommend setting the CD command to EXTERNAL in these units to allow the radio to provide carrier detection to the KPC-2/KPC-2400. If you prefer, you can set the CD command to SOFTWARE, allowing the KPC-2/KPC-2400 to detect the presence of data on the channel to signal carrier detect.

If you are using the KPC-2400 at 2400 baud, you can connect the unsquelched and unshaped audio (pin 5 of the D4-10) to the audio input (pin 5) of the KPC-2400, instead of connecting to the speaker audio from pin 8 of the D4-10.

Radio Pin Name	D4-10 Pin	KPC-2/2400 Pin	TNC Pin Name
Data Input	1	1	AFSK Out
Carrier Detect	2	2	XCD
Push-to-Talk	3	3	PTT
Ground	6	6	Ground
Speaker Audio Out	8	5	Audio Signal

Set TNC command: EQUALIZE OFF

Set AFSK output jumper to HI (50 mv p-p)

NOTE:

Pins 4, 7, and 9 are reserved for future use and should not be connected to your TNC.

DB-9 Connector

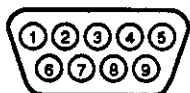

Male (Looking at Pins)

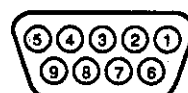

Female (Looking at Holes)

KPC-1

Connecting your KPC-1 to the D4-10 analog port requires the following connections:

Pin 1 from the KPC-1 din connector should be connected to pin 1 of the DB-9 (analog port) on your radio. Pin 2 of the KPC-1 connects to pin 6, and pin 3 of the KPC-1 will connect to pin 3 on the radio. Connect the external speaker jack from the D4-10 to the audio input jack on the rear panel of the KPC-1.

Now set the equalization to none by using the command EQUALIZE OFF. Connect an external speaker to the external speaker jack on the rear panel of the D4-10, and adjust the squelch control just beyond the point where the open squelch can be heard through an external speaker. If you don't use an external speaker, you can adjust the squelch control to the point where the RCV led on your TNC goes out.

Radio Pin Name	D4-10 Pin	KPC-1 Pin	TNC Pin Name
Data Input	1	1	AFSK Out
Push-to-Talk	3	3	PTT
Ground	6	2	Ground
External Speaker Jack	-	-	Audio Input Jack

Set TNC command: EQUALIZE OFF
Set AFSK output jumper to HI (50 mv p-p)

NOTE:

Pins 4, 7, and 9 are reserved for future use and should not be connected to your TNC.

DB-9 Connector

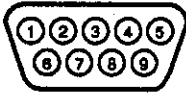

Male (Looking at Pins)



Female (Looking at Holes)

5-Pin Din

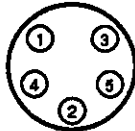

Male (Looking at Pins)

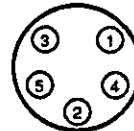

Female (Looking at Holes)

Connecting Other TNCs to the D4-10

AEA PK-232

Pin 1 of the D4-10 analog port will connect to pin 2 of the 232's 5 pin radio connector (white wire on the AEA supplied cable).

Pin 2 from the D4-10 may be used to supply the carrier detect by connecting this to pin 3 (black) on the TNC (optional).

Pin 3 of the D4-10 will connect to pin 5 on the 232 (red wire).

Pin 6 of the D4-10 connects to pin 4 on the 232 (brown wire).

Pin 8 from the D4-10 may be connected to pin 1 (green) on the PK-232, providing speaker audio (controlled by the front panel volume and squelch controls).

(Although the D4-10 is capable of supplying un-squelched and unshaped audio to the TNC, we have not tested the PK-232 in this configuration. If you want to use the un-squelched audio from pin 5 of the D4-10, we suggest you contact AEA for instructions concerning the use of unshaped audio.)

Radio Pin Name	D4-10 Pin	PK-232 Pin	TNC Pin Name
Data Input	1	2	TX Audio
Carrier Detect	2	3	SQ
Push-to-Talk	3	5	PTT
Ground	6	4	Ground
Speaker Audio Out	8	1	RX Audio

NOTE:

Pins 4, 7, and 9 are reserved for future use and should not be connected to your TNC.

DB-9 Connector



Male (Looking at Pins)

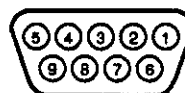

Female (Looking at Holes)

PK-232 Connector

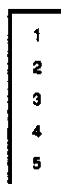

MFJ-1270 or equivalent

Pin 1 of the D4-10 analog port will connect to pin 1 of the 5 pin din connector on the rear panel of the TNC.

Pin 2 of the D4-10 may be used to supply the carrier detect by connecting this to pin 5.

Pin 3 of the D4-10 connects to pin 3.

Pin 6 of the D4-10 connect to pin 2.

Pin 8 of the D4-10 connects to pin 4. This supplies speaker audio which is controlled by the front panel volume control.

(Although the D4-10 is capable of supplying unswitched and unshaped audio to the TNC, we have not tested the MFJ TNCs in this configuration. If you want to use unswitched audio from pin 5 of the D4-10, we suggest you contact MFJ for instructions concerning the use of unswitched audio.)

Radio Pin Name	D4-10 Pin	MFJ-1270 Pin	TNC Pin Name
Data Input	1	1	Microphone audio
Carrier Detect	2	5	Squelch input (optional)
Push-to-Talk	3	3	PTT
Ground	6	2	Ground
Speaker Audio Out	8	4	Receive audio

NOTE:

Pins 4, 7, and 9 are reserved for future use and should not be connected to your TNC.

DB-9 Connector



Male (Looking at Pins)



Female (Looking at Holes)

5-Pin Din

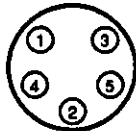

Male (Looking at Pins)

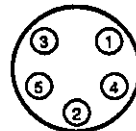

Female (Looking at Holes)

Operation

The transmitter will come up to full operating power within 5 milliseconds after the push-to-talk line is pulled to ground, allowing your TXDELAY setting to be extremely short. Typically a TXDELAY setting of 1 will allow full power to be present before the data begins. However, since the receiving station requires some time to detect the presence of your signal (squelch time), you will need to increase your TXDELAY to account for this.

The D4-10 has been designed to detect a signal present on frequency within 10 milliseconds (squelch time). This means that if you are communicating with another D4-10, you can set your TXDELAY at 2 and allow sufficient time for your transmitter to come up to full power and for the receiving D4-10 to detect the presence of your signal.

When operating with the unsquelched audio output (pin 5 of the D4-10), many TNCs require the use of an external means to detect the presence of a signal. This is provided by the D4-10 on pin 2 of the DB-9 connector (CD). Pin 2 will be pulled low (ground) when a received signal is detected, and therefore can signal the TNC to demodulate the signal. On the Kantronics KAM, KPC-4, KPC-2, and KPC-2400, this is accomplished by connecting pin 2 of the D4-10 to pin 2 of the TNC and setting the CD command to EXTERNAL. On the Data Engine with DE1200 or DE2400 modems, this is accomplished by wiring pin 2 of the D4-10 to pin 2 of the Data Engine Radio port. You must also set the Data Engine MODEM command to recognize this external signal. Refer to your Data Engine Modem manual.

Alternatively, you can utilize the firmware carrier detect feature of all Kantronics TNCs (sometimes called software CD). In this case, wiring of the CD line from the D4-10 will be unnecessary, and access to the squelch pot will not be necessary.

When operating at high speed: 9600 or 19,200

Here, again, TXD (transmitter delay) is important. We've found that a TXD of 3 or so will allow good linking between two stations utilizing the Data Engine and DE19K2/9K6 modem at either data rate. Also, again, carrier detect is not an issue here; the modem develops and presents its own CD to the Data Engine.

TXDELAY Settings

The D4-10 is capable of operating with a TXDELAY setting of 1 if you are talking to another user who has a D4-10. Field testing with an RF Concepts 4-110 amplifier (RF keyed) has shown a TXDELAY setting of 15 to be sufficient. In many cases, you may be talking with someone who is using a radio that does not provide the high speed switching necessary to use these fast settings, and therefore you will need to increase your TXDELAY to operate effectively. This will also be true if you are using a digipeater which has a slower radio connected to it. To test the amount of TXDELAY required for a specific digipeater, set your UNPROTO command to include the desired digipeater as the first digipeater in your path. Then enter the converse mode and press a return. This will cause a packet to be sent through the digipeater, but the digipeater will not repeat it unless it has heard the packet completely. Start increasing your TXDELAY slowly and try transmitting another packet. Continue this process until your packets are reliably repeated by the digipeater. If you have the MONITOR command ON, you will be able to monitor your digipeated packets on your terminal.

If you use several different digipeaters, repeat this process with all of them, and then set your TXDELAY for the worst case you find in your tests (highest value of TXDELAY).

NOTE: Many nodes (Net/Rom®, TheNet, etc.) will not allow the digipeating of packets. In these cases, you will need to attempt to connect to the node, increasing your TXDELAY until you reliably establish a connection.

In Case of Difficulty

Power light fails to light

1. Check to be sure the D4-10 is connected to a source of 12 volts DC.
2. Check the polarity of your 12 volt supply – red lead is positive. If the power was connected with reverse polarity, the fuse inside the D4-10 will have to be replaced. (See assembly/disassembly instructions.) The fuse is a 10-amp 3AG type fuse.

No audio output from external speaker jack

1. Check to be sure external speaker is plugged in to the rear panel speaker jack. Be sure it is firmly seated in the connector.
2. Check the volume control to ensure it is not turned all the way counter-clockwise.
3. Be sure power is turned on to the radio.

No audio output from TNC jack (pin 1)

1. If speaker audio is not present, this may indicate detector output is not working.

Unit will not transmit

1. Be sure the push-to-talk line (pin 3 of either DB-9 port) is properly connected to your TNC.
2. Apply a ground to pin 3 of the DB-9 connector, and check the front panel transmit LED. (Remember to have an antenna or dummy load attached during this test.) If it lights, this indicates a problem with the microphone or TNC connection.

Unit transmits, but no audio is present

1. Check the connection to your TNC or microphone. The proper input level from a TNC to pin 1 of the DB-9 modem connector is 50 mv peak-to-peak for the D4-10 analog port.

Disassembly Instructions

1. Disconnect all cables from the D4-10.
2. Remove the screws from the bottom of the case that secure the heat sink to the case.
3. Loosen the two screws that mount the rear panel to the bezel far enough to allow the rear panel and bezel assembly to be pulled away from the case.
4. Carefully slide the entire rear panel and circuit board assembly out of the case.
5. If you need to remove the rear panel, unscrew the four mounting nuts which secure the rear panel to the DB-9 connectors.

Assembly Instructions

1. Install the back panel onto the circuit board, if detached, securing it with the four mounting nuts into the DB-9 connectors.
2. Carefully insert the circuit board assembly into the rear of the case. Ensure that the LEDs and switches properly line up with the cutouts in the front panel. If desired, you may find it easier to remove the front panel until the board is secured in place.
3. Secure the rear panel to the case with the two screws provided.
4. Reinstall and tighten the screws through the bottom of the case into the heat sink.

Ordering Crystals

You may wish to order additional crystals for your D4-10 radio. Kantronics will stock a few "standard" channels, based on popularity and demand – mainly centered around 430.55 MHz. If you wish to use other frequencies, then the following information should be sufficient when ordering receive (RX) and transmit (TX) crystals from a crystal house.

CAUTION: Please read the tuning up section to follow. You may wish the factory or someone with solid test equipment to do channel changing for you.

To calculate the transmit frequency of the fundamental crystal, divide the operating frequency by 64.

$$\text{TX crystal frequency} = \text{operating frequency}/64.$$

To calculate the receive frequency of the fundamental crystal, subtract 45 MHz from the operating frequency and then divide by 64.

$$\text{RX crystal frequency} = (\text{operating frequency} - 45 \text{ MHz})/64.$$

Crystal Specifications

The crystals should be ordered with the following specifications:

1. Fundamental mode
2. Frequency make, ± 10 ppm (parts per million)
3. Series resonant
4. Resistance at 75 ohms, max
5. $C_0 = 7$ pf max, 5 pf typical (pf = picofarads)
6. Drive level 10 mw max
7. Temperature stability: ± 30 ppm -30°C to $+60^\circ\text{C}$
8. Case: HC-50/u or HC-42/u
9. Markings (optional): transmit, T freq + "T"; receive, R freq + "R"

The ARRL 100 KHz, 440 MHz bandplan calls for these wide channels centered at 430.05, 430.15, 430.25, 430.35, 430.45, 430.55, 430.65, 430.85 and 430.95 MHz. If the use of these frequencies is in question in your area, consult with your local frequency coordinator or council.

Installing Crystals and Tuning Up

As per the caution above, tuning the radio after installing new crystals requires good equipment and some experience. For those cases where the frequency change is small, we've tried to help by pre-tuning both channels at the factory to our test standard, 430.55 MHz. So, if you are planning to add crystals for channel two that are within a few hundred KHz of 430.55, only the tuning of the crystal oscillators themselves should be necessary. If so, be careful to not "detune" channel one.

The pc board sockets for crystals for channels one and two are located at the right front of the board. The channel one and two transmit sockets are labeled TX1 and TX2. The receive sockets are labeled RX1 and RX2. You can also locate these on the parts placement diagram at the end of this manual.

Tuning the D4-10 for transmit and receive after crystal installation is best completed with a service monitor (RF generator with SINAD meter, etc.) and a spectrum analyzer. However, it is likely that most amateurs will not have this equipment and that probably most amateur radio stores will not either. Hence, if desired, Kantronics will install and tune crystals for a nominal fee. You must contact the Service Department (913) 842-4476 to obtain a Return Authorization Number for this service. They can also advise the current charges for this service. Failure to obtain a return authorization number may result in the unit being returned unopened.

If you wish to attempt to tune the unit without this highly recommended equipment, then here is a procedure that works for experienced technicians:

1. Using a counter (optional but a good idea), attach its input to the emitter of Q12 or Q16 (or safer to the top of resistor R104), and adjust the receive and transmit crystals as close to "on frequency" as possible.
 - 1a. For receive, adjust coil RL1 or RL2 (channel one or two) until the counter reads your "desired operating frequency - 45 MHz" divided by 64. That is, the counter frequency should read:
$$RX = (\text{operating frequency} - 45 \text{ MHz})/64.$$
 - 1b. For transmit, attach a dummy load to your antenna terminal, and then KEY the transmitter at pin 3 or the analog port. Adjust coil TL1 or TL2 until the counter reads the operating frequency divided by 64.

Additional or Alternative Tuning

Receive

2. Note the four small potentiometers (pots) at the front right side of the board. They are labeled RXA1, and RXA2 for receive channels one and two and TXA1 and TXA2 for the transmit channels. These are used to bring the VCO near the desired operating frequency. This, by the way, allows fast TR switching. Now, suppose that you wish to tune for the second receive channel. Turn RXA2 full clockwise, toward the back of the unit. Then attach a VOM to test point JP2, using the pin toward the back. Slowly increase pot RXA2 until the voltage reads 2.5 VDC on the VOM. This is the "lock voltage".
3. Using another FM rig attached to a dummy load or some blocks away, generate a carrier with a one KHz modulating tone to tune to on your proposed operating frequency.

4. Adjust the coil in series with the receive crystal (RL1 or RL2) until the 1 KHz tone comes in clearly. Continue to turn the coil until the signal just begins to distort. Then turn the coil in the opposite direction (providing a clear signal again) and continue turning until the signal just begins to distort again. Now set the coil approximately half-way between these two points. This should provide best clarity.
5. If you plan to operate the D4-10 outside the 428 to 432 MHz band, then you will also need to "tweak up" the helicals at the front end of the receiver, labeled FL1 and FL2. Slowly peak for best reception.

Transmit

6. To complete transmit tuning, you'll need a counter, a dummy load and a accurate DC voltmeter. Attach the dummy load now.
7. Next, you will be tuning the phase lock loop (PLL) so that the transmit crystal will work properly with the 64 X loop. That is, you'll adjust the "pre-steering" voltage on the voltage controlled oscillator (VCO) so that the PLL locks. Before completing this step you may want to read the next section and review the block diagram for the transceiver.
8. Note the four small potentiometers (pots) at the front right side of the board. They are labeled RXA1, and RXA2 for receive channels one and two and TXA1 and TXA2 for the transmit channels. These are used to bring the VCO near the desired operating frequency. This, by the way, allows fast TR switching. Now, suppose that you wish to tune for the second transmit channel. Turn TXA2 full clockwise, toward the back of the unit. Then attach a VOM to test point JP2, using the pin toward the back. Key the transmitter at pin 3 on the analog port, and slowly increase pot TXA2 until the voltage reads 2.5 VDC on the VOM. This is the "lock voltage". The red transmit LED will light when the PLL is locked.

Please keep in mind that this takes some practice and you must turn the pot very slowly. You can check your frequency of operation by transmitting some packets to the other transceiver you are using for the receive test. Alternatively you can check the transmit frequency with a good RF counter with antenna.

No other adjustments should be necessary if you've not changed anything other than channel crystals.

Return/Repair Procedures

Should you feel that your unit is malfunctioning, you should contact the Kantronics Service Department (913-842-4476) between the hours of 9AM-12N or 2PM-5PM Central Time to obtain a return authorization number (RA number). The unit may then be returned to the factory at 1202 E. 23rd Street, Lawrence, KS 66046 for service. Please include a letter indicating the problem you are experiencing and, if appropriate, the method of payment for repairs. Kantronics will accept Master Card or Visa, or you may elect to have your unit returned to you COD.

Limited Warranty

Kantronics Company, Inc. warrants to the first consumer purchaser, for a period of one year from the date of purchase, that this product will be free from defects in material and workmanship, and agrees that it will, at its option, repair or replace the defective parts or the product at no charge for parts or labor.

This warranty does not apply to the cosmetic appearance of the product, or to any product that has been subject to misuse, abuse, overvoltage, or other cause beyond our reasonable control.

This warranty does not apply to any unit that has been modified by the consumer unless specifically authorized by Kantronics Company, Inc, in writing.

In no event shall Kantronics be held liable for damages due to fire, flood, civil disobedience, riot, acts of God or damages incurred in shipping due to poor packaging. Kantronics shall not be held liable in the event the defect is found to be caused by improper parameter settings which are cleared by performing a hard reset.

Kantronics shall not be liable for any incidental or consequential damages arising from the use of the product or due to the non-availability for use of the product under any circumstances.

Some States do not allow the exclusion or limitation of incidental or consequential damages, so the above limitation or exclusion may not apply to you.

In order to enforce the rights under this limited warranty, the purchaser should mail, ship or carry the product, together with proof of purchase, to Kantronics Company, Inc, 1202 East 23rd Street, Lawrence, Kansas 66046. The consumer must also provide adequate proof of purchase indicating the date the product was purchased.

There are no other warranties, including the implied warranty of fitness for a particular purpose, not specified herein with regards to this product. Neither the sales personnel of the seller nor any other person is authorized to make any warranties other than those described herein, or to extend the duration of any warranties beyond the time period described above.

This warranty is not assignable by the original consumer. Any attempt to assign or transfer any of the rights, duties or obligations hereof is void.

Any product returned for warranty service and our inspection and testing shall determine no defect exists which is covered by this warranty, shall be charged a minimum of one-half hour labor plus return shipping charges.

This warranty gives you specific legal rights and you may also have other rights which vary from State to State.

Specifications

Receiver

freq coverage	428-436 MHz
freq control	crystal
temp-range	-10/60 °C
freq stability	±10 ppm
design	triple conv
front end:	
design	2 by 2
transistor	MRF571
first mixer	GaAsFET MRF966
spurious rej	-60 dB
first IF	45 MHz
filter, FL1	discrete
2nd IF	10.7 MHz
filter, FL2	SFE10.7J
3rd IF	455 KHz
filter, FL3A	discrete 60-KHz
filter, FL3B	CFW455C
sensitivity:	
+12 dB SINAD	0.5 µV (-113 dBm)
10 ⁻³ BER (note 1)	<1 µv (-107 dBm)
main chip	MC3362
antenna switch	PINS
DC supply	+12 VDC
current	<200 ma

Transmitter

modulation	varactor
nom deviation	
wide band data	±9.6 KHz
TXD drive	TTL
nom deviation	
narrow band data	±3 KHz
TXA drive	50 mv p-p
max deviation	
voice operation	±4.5 KHz
spurious emission	-60 dB
Mic impedance	600 ohms
DC supply	+12 VDC
current	<2.5 amps
watts output	>10

NOTE 1: in conjunction with Data Engine and DE19K2 modem.

D4-10 Parts List

Part Desig	Layout Schem		Part Description	Part Desig	Layout Schem		Part Description
	Locat	Locat			Locat	Locat	
C1	H4	A3	470pF	C51	F3	C5	220pF
C2	H2	A5	470pF	C52	G4	C5	.01uF
C3	G3	B5	470pF	C53	G5	A6	.047uF
C4	H5	A6	470pF	C54	F1	D6	27pF Mini Chip
C5	H5	A5	470pF	C55	F1	D6	27pF Mini Chip
C6	H1	D6	.001uF	C56	F3	C4	.01uF
C7	H1	C6	3.3pF	C57	F2	D5	SPRG GYA15000
C8	H1	C6	47pF	C58	F3	C4	56pF
C9	H2	A5	470pF	C59	F4	A6	220uF Al 16V
C10	H2	B5	470pF	C60	F5	A6	470pF
C11	H5	A5	470pF	C61	F4	C3	18pF
C12	H5	B5	470pF	C62	F2	D6	75pF
C13	H2	C6	220pF	C63	F4	C3	.01uF
C14	H2	C6	220pF	C64	F4	A6	56pF
C15	H3	B5	470pF	C65	F5	A3	.1uF
C16	H3	A3	.1uF	C66	F5	A6	120pF
C17	H4	B6	.1uF	C67	F5	A6	.0022uF
C18	H4	A3	.1uF	C68	F2	D5	.01uF
C19	H5	A5	470pF	C69	F5	A6	.001uF
C20	H5	B5	470pF	C70	E1	D5	.001uF
C21	G1	D6	470pF	C71	E2	D5	.01uF
C22	H2	C6	220pF	C73	F3	C4	22pF
C23	G5	B6	.033uF	C74	E3	C4	120pF
C24	H5	B5	1uF Al	C75	E3	C4	1.8pF
C25	H5	A5	220uF Al 16V	C76	E3	C3	.01uF
C26	G1	D6	470pF	C77	F4	C3	.01uF
C27	G2	D6	SPRG GYA15000	C78	E4	B3	.01uF
C28	G5	B6	.047uF	C79	E5	A6	220pF
C29	G1	D6	27pF Mini Chip	C80	E5	A6	.018uF
C30	G2	C6	220pF	C81	E1	D5	.1uF
C31	G4	B5	.1uF	C82	E3	C4	100pF
C32	G4	A5	.1uF	C83	E1	D5	1uF Al
C33	G5	A5	.1uF	C84	E3	C4	75pF
C34	G3	C5	.01uF	C85	E5	A6	56pF
C35	G4	A5	4.7uF Al	C86	E5	B4	180pF
C36	G1	D6	.1uF	C87	E2	D5	30pF Mini Chip
C37	G2	C5	220pF	C88	E3	C4	27pF
C38	G3	C5	220pF	C89	E3	C4	.01uF
C39	G3	C5	220pF	C90	E4	C4	100pF
C40	G4	C5	3.3pF	C91	E4	C4	47pF
C41	G4	A5	.0027uF	C92	E4	B4	.1uF
C42	G5	A5	.01uF	C93	E4	B4	.1uF
C43	G2	D6	.01uF	C94	E4	B4	.1uF
C44	G2	C5	220pF	C95	E1	D5	.1uF
C45	G3	C5	220pF	C96	E1	D5	.001uF
C46	G3	C5	22pF	C97	E4	B4	.1uF
C47	G4	C5	220pF	C98	D1	D5	SPRG GYA15000
C48	G5	A6	220uF Al 16V	C99	D4	A4	75pF
C49	F1	D6	10uF Al 35V	C100	D4	B4	.01uF
C50	G2	D6	1uF Al	C101	D4	B4	.01uF

Part Desig	Layout Locat	Schem Locat	Part Description
C102	D4	A5	.0022uF
C103	D5	B4	.1uF
C104	D2	D5	33pF
C105	D4	B5	470pF
C106	D3	D3	22uF Al
C107	D4	B4	330pF
C108	D4	A4	27pF
C109	D2	D4	SPRG GYA15000
C110	D4	D2	.1uF
C111	D4	C3	.1uF
C112	D4	A4	560pF
C113	D5	B4	.0012uF
C114	D3	D3	220pF
C115	D3	D3	3.6pF
C116	C1	D4	220pF
C117	C1	D4	.1uF
C118	C3	D3	100pF
C119	C3	D3	3.6pF
C120	C3	D3	220pF
C121	C3	D3	220pF
C122	C5	C3	.1uF
C123	C2	D4	470pF
C124	C3	D2	.01uF
C125	C2	D3	220pF
C126	C2	D4	220pF
C127	C3	D3	220pF
C128	C4	C2	.01uF
C129	C4	C2	.001uF
C130	C1	D4	220pF
C131	C3	D3	22uF Al
C132	C4	C3	.015uF
C133	C3	D2	100pF Mini Chip
C134	C3	D3	220pF
C135	C3	D2	220pF
C136	C4	D2	.001uF
C137	B2	D3	.001uF
C138	C3	D3	3.3pF
C139	B4	C2	.001uF
C140	B4	D2	.01uF
C141	B5	D2	.01uF
C142	B2	D4	7.5pF
C143	B2	D3	7.5pF
C144	B2	D3	7.5pF
C145	B4	C2	.01uF
C146	B4	C2	100pF
C147	B5	C2	.001uF
C148	B5	B2	.01uF
C149	B1	D3	.001uF
C150	B2	D3	7.5pF
C151	B3	C3	220pF
C152	B3	D3	220pF
C154	B5	C2	.01uF

Part Desig	Layout Locat	Schem Locat	Part Description
C155	B2	B2	1uF Tant
C156	B4	C2	220pF
C157	B4	C1	.001uF
C158	B4	C3	.01uF
C159	B5	B2	.01uF
C160	B1	A1	.47uF Al
C161	B5	B2	100pF
C162	B5	B2	220pF
C163	A3	A2	220uF Al 25V
C164	C4	D2	4.7uF Al
C165	D5	B4	6.2pF Cer Mini
CF1	E4	B3	SFE10.7M3-A
D1	H3	B5	1N914
D2	H3	B5	1N914
D3	H3	B5	1N914
D4	H1	C6	UM9401
D5	H2	C6	UM9401
D6	F5	A6	1N914
D7	F5	A6	1N914
D8	F1	D6	1N4003
D9	E5	B4	1N914
D10	E5	B3	1N914
D11	C3	D3	MMBV105G
D12	C2	D4	MPN3404
D13	C2	D4	MPN3404
D14	C1	D4	1N756
D15	B1	D3	1N914
D16	B5	C3	MV2114
D17	B3	B2	1N914
D18	B3	B2	1N914
D19	B5	B3	MV2114
D20	A2	A2	1N4003
D21	A1	A2	Green LED
D22	A2	B2	Red LED
F1	A2	A2	MOUS44FH053
FL1	G2	C6	TK 5HW40545A430
FL2	F3	C5	TK 5HW40545A430
J1	I4		MLX39-29-1028
J1-1		A3	MLX39-29-1028
J1-2		A3	MLX39-29-1028
J2	I4	A4	3.5mm
J3	H1	C6	AMP227661-1
J4	H3	A4	DB9F PC mount
J5	H5	A4	DB9F PC mount
J6	F4	C4	3P SIH
J7	D5	B5	6P SIH
J8	A5	C4	6P SIH
JP1	D4	B4	2P SIH
JP2	C4	C2	2P SIH
L1	H4	A3	FER 21-200J
L2	H2	C6	.33uH
L3	H1	D6	CCFT 164-06A06S

2 PARTS LIST

D4-10
June 13, 1991

© Copyright 1991, Kantronics Co., Inc. All Rights Reserved.
Duplication of this manual without permission
of Kantronics Co., Inc. is prohibited.

Part Desig	Layout Locat	Schem Locat	Part Description	Part Desig	Layout Locat	Schem Locat	Part Description
L4	H2	C6	.33uH	Q18	B5	B2	PN2222
L5	G1	D6	FER 21-200J	R1	H1	C6	10K 1/8W
L6	G1	D6	CCFT 164-02A06S	R2	H2	C6	470
L7	G2	D6	.15uH	R3	H2	C6	620 1/8W
L8	G3	C5	.33uH	R4	H3	B6	100K 1/8W
L9	G4	C5	2.2uH	R5	H3	B5	1K 1/8W
L10	G3	C5	CCFT 165-03A06	R6	H4	B5	10K 1/8W
L11	F2	D5	.15uH	R7	H4	B6	100 1/8W
L12	F3	C4	CCFT150-04J08S	R8	H5	B6	8.2K 1/8W
L13	E1	D5	FER 21-200J	R9	H5	B6	680 1/8W
L14	E2	D5	CCFT 164-06A06S	R10	H2	C6	2.2K 1/8W
L15	E4	C3	.68uH	R11	H3	B6	ME321-2100-250K
L16	E4	C3	.68uH	R13	G3	B6	47K 1/8W
L17	E3	C4	CCFT150-05J08S	R14	G4	B6	1K 1/8W
L18	E3	D5	.27uH	R15	G5	A5	2.7 1/8W
L19	E5	B4	CFTSLOT-TEN-5-18	R16	G2	C6	1.8K 1/8W
L20	D1	D5	FRT 2643000101	R17	G3	B6	ME321-2100-1K
L21	D3	B5	CFTSLOT-TEN-5-16	R18	G3	B6	4.7K 1/8W
L22	D1	D5	CCFT 164-06A06S	R19	G3	B6	3.9K 1/8W
L23	D4	B4	CFTSLOT-TEN-5-16	R20	G4	B5	22K 1/8W
L24	D4	B4	CFTSLOT-TEN-5-16	R21	G4	B5	33K 1/8W
L25	C5	C1	1.2uH	R22	G6	A6	2.2K 1/8W
L26	C1	D4	.33uH	R23	G2	C5	220
L27	C3	D3	.22uH	R24	G3	B6	5.1K 1/8W
L28	C1	D4	FRT 2643000101	R25	G3	C5	470 1/8W
L29	C2	D4	CCFT 164-02A06S	R26	G4	A5	1K 1/8W
L30	C2	D4	1.2uH	R28	G3	C5	100 1/8W
L31	B3	D3	820uH	R29	G4	C5	39 1/8W
L32	B2	D3	CCFT 164-01A06S	R30	G5	A5	100K 1/8W
L33	B5	B2	3.3uH	R31	G5	A5	390 1/8W
L34	A4	C2	6.8uH	R32	G5	A5	220 1/8W
Q1	G2	C5	MRF571	R33	G3	C5	10 1/8W
Q2	G5	A5	2N7000	R34	G4	A6	220K 1/8W
Q3	G3	C5	MRF966	R35	F5	A6	7.5K 1/8W
Q4	G1	D6	BLU20/12	R36	G5	A6	1K 1/8W
Q5	E2	D5	MRF630	R37	G6	B6	22K 1/8W
Q6	E4	B4	PN2222	R38	F2	D6	10 1/2W
Q7	D1	D5	MRF559	R39	F4	C5	120 1/8W
Q8	C3	D3	MPS5179	R40	F4	A6	220K 1/8W
Q9	C2	D4	MRF571	R41	F5	A6	7.5K 1/8W
Q10	B3	D3	MPS5179	R42	F5	A6	18K 1/8W
Q11	B4	C2	PN2222	R43	F5	A6	10K 1/8W
Q12	B5	C2	PN2222	R44	F5	A6	10K 1/8W
Q13	B1	A2	PN2907A	R45	F6	A6	390K 1/8W
Q14	B2	A2	PN2907A	R46	F1	D6	120 2W MT
Q15	B2	B2	PN2222	R47	F4	C3	10K 1/8W
Q16	B5	B2	PN2222	R48	F4	A6	8.2K 1/8W
Q17	B2	B2	PN2907A	R49	F5	A6	18K 1/8W
				R50	F6	A6	82K 1/8W
				R51	F2	D5	10
				R52	F5	A6	75K 1/8W
				R53	F5	A6	10K 1/8W

PARTS LIST 3

Part Desig	Layout Locat	Schem Locat	Part Description
R54	F5	A6	82K 1/8W
R55	F5	A6	18K 1/8W
R56	E4	C3	1K 1/8W
R57	E4	C3	10K 1/8W
R58	E4	A6	430K 1/8W
R59	E5	B3	4.7K 1/8W
R60	E5	A6	18K 1/8W
R61	E5	B3	100K 1/8W
R62	E5	A6	82K 1/8W
R63	E3	D5	10
R64	E5	B4	43K 1/8W
R65	E5	B4	270K 1/8W
R66	E5	B4	33K 1/8W
R67	E4	B5	4.7K 1/8W
R68	E5	B4	10M 1/8W
R69	E5	B4	10K 1/8W
R70	D5	B4	22K 1/8W
R71	D5	B4	22K 1/8W
R72	D5	B4	43K 1/8W
R73	D2	D5	10 1/8W
R74	D5	B4	4.7K 1/8W
R75	D3	D3	560 1/8W
R76	D5	C1	220K 1/8W
R77	D1	D5	4.7
R78	D2	D4	10 1/8W
R79	D2	D4	100 1/8W
R80	D3	D3	620 1/8W
R81	C3	D3	220 1/8W
R82	D4	D2	220K 1/8W
R83	D4	C3	220K 1/8W
R84	C5	C1	100K 1/8W
R85	C1	D4	220
R86	C3	D2	100K 1/8W
R87	C4	D2	100K 1/8W
R88	C4	D2	22K 1/8W
R89	C4	C3	100K 1/8W
R90	C5	C3	220K 1/8W
R91	C1	D4	220
R92	C4	D2	220K 1/8W
R93	C2	D3	100 1/8W
R94	C4	C2	1.2K 1/8W
R95	B4	C1	470 1/8W
R96	B4	C3	47K 1/8W
R97	B4	C3	100K 1/8W
R98	B1	D4	10 1/8W
R99	B1	D4	68 1/8W
R100	B2	D3	390
R101	B4	C3	1K 1/8W
R102	B4	C2	10K 1/8W
R103	B4	C2	100K 1/8W
R104	B5	C2	1K 1/8W
R105	B5	B2	10K 1/8W

Part Desig	Layout Locat	Schem Locat	Part Description
R106	B2	D4	2.7K
R107	B4	C2	1K 1/8W
R108	B5	C2	4.7K 1/8W
R109	B5	C2	10K 1/8W
R110	B5	C2	15K 1/8W
R111	B1	A2	22K 1/8W
R112	B2	B2	8.2K 1/8W
R113	B2	A2	47 1W
R114	B2	A2	2.2K 1/8W
R115	B3	C3	470 1/8W
R116	B5	B2	4.7K 1/8W
R117	B5	B2	15K 1/8W
R118	B1	B1	1K
R119	B2	A2	1.5K 1/8W
R120	B2	B2	560 1/8W
R121	B5	B2	1K 1/8W
R122	A2	A2	10K 1/8W
R123	A3	C3	100K 1/8W
R124	A4	C3	100K 1/8W
R125	A2	B2	1K
R126	A5	C3	100K 1/8W
R127	A2	A2	1K
R128	A2	B4	ME321-2100-100K
R130	A4	B6	ME321-2100-10K
R132	A5	B3	47K 1/8W
R133	F2	C5	220 1/8W
RL1	B3	C3	CFTSLOT-TEN-4-07
RL2	B4	C3	CFTSLOT-TEN-4-07
RX1	A4	C3	HC-50 Socket
RX2	A4	C3	HC-50 Socket
RXA1	C5	C1	ME321-2100-10K
RXA2	C5	C1	ME321-2100-10K
SW1	A1		PHA012U10EEM
SW1B		A2	PHA012U10EEM
SW1A		A2	PHA012U10EEM
SW2	A4		PHA014U10EEM
SW2B		B3	PHA014U10EEM
SW2D		C3	PHA014U10EEM
SW2A		C2	PHA014U10EEM
SW2C		B2	PHA014U10EEM
SW3	A5		PHA012U10EEM
SW3A		B4	PHA012U10EEM
SW3B		A2	PHA012U10EEM
SW4	A5		PHA012U10EEM
SW4A		C3	PHA012U10EEM
TL1	B3	B3	CFTSLOT-TEN-4-07
TL2	B4	B3	CFTSLOT-TEN-4-07
TX1	B4	B3	HC-50 Socket

4 PARTS LIST

D4-10

June 13, 1991

© Copyright 1991, Kantronics Co., Inc. All Rights Reserved.
 Duplication of this manual without permission
 of Kantronics Co., Inc. is prohibited.

Part Desig	Layout Locat	Schem Locat	Part Description
TX2	B4	B3	HC-50 Socket
TXA1	C5	C1	ME321-2100-10K
TXA2	D5	C1	ME321-2100-10K
U1	G3		LM393N
U1C		A3	LM393N
U1B		B5	LM393N
U1A		B6	LM393N
U2	G4	B5	CA3080E
U3	G4		LM358N
U3C		A3	LM358N
U3A		A4	LM358N
U3B		B6	LM358N
U4	G4	B5	LM380N
U5	F5		LM324
U5A		A6	LM324
U5B		A6	LM324
U5C		A6	LM324
U5E		A3	LM324
U5D		A6	LM324

Part Desig	Layout Locat	Schem Locat	Part Description
U6	E4	C4	MC3362P
U7	D4	B4	CD4053E
U8	C4		LM358N
U8A		D2	LM358N
U8C		D2	LM358N
U8B		C3	LM358N
U9	C4	D2	NEC UPB562C
U10	B3	D3	MINI CIR MAR1
U11	C5	C2	CD74HCT4046E
U12	B5	C1	CD4052E
V1	H4	A3	60PAD
V2	G1	D6	60PAD
V3	A2	A2	60PAD
V4	A1	A3	60PAD
VR1	B1	A1	LM78L05
X1	F4	C3	34.3MHz
X2	E4	C4	11.155MHz
XF1	D4	B5	CFW455B

Parts Layout

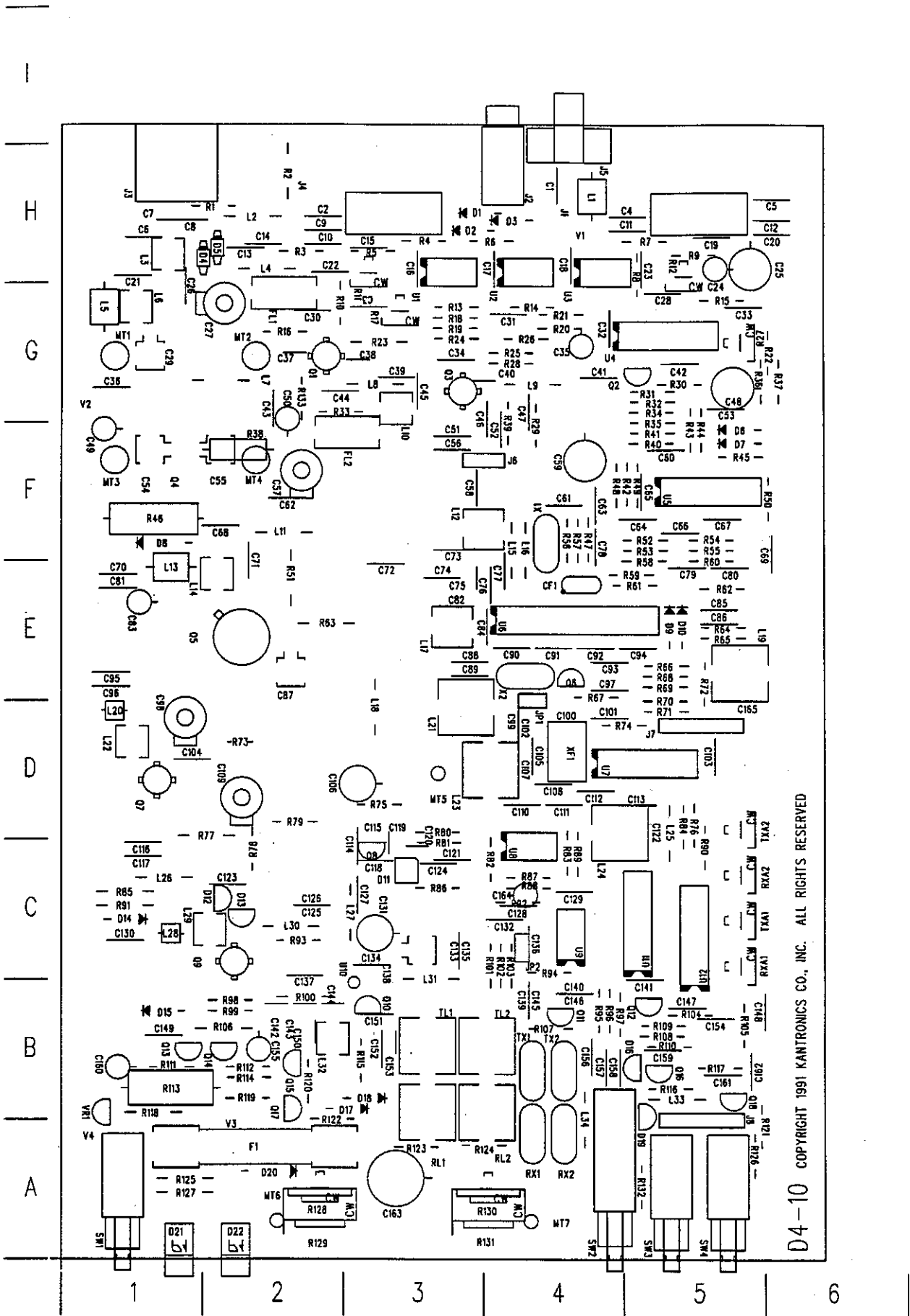

D4-10 COPYRIGHT 1991 KANTRONICS CO., INC. ALL RIGHTS RESERVED

Block Diagram Description of the D4-10

After considering a number of alternatives, regulatory requirements and available ICs and power transistors, an overall design, shown in block diagram form in Figure 1, evolved. The receiver, like the DVR 2-2, is built around the Motorola 3362, with a 45 MHz first IF added, resulting in a triple-conversion receiver. The 455 KHz IF has two filters built in, switch selectable by the operator. The "W" or wide position selects the 3-pole, discrete 60 KHz filter. "N" selects the normal narrow band filter, a Murata CFW455B. The 60 KHz filter enables the D4-10 to easily handle 19,200 baud data, and it leaves room for experimentation with other wide band modes and speeds.

The transmitter, like the DVR 2-2, modulates the RF carrier indirectly by utilizing a varicap to pull the transmitter crystal oscillator. Three separate inputs can provide modulation, Mic, transmit audio at the analog port (TXA) and TTL signals at the digital port (TXD). The analog port is pin-for-pin and functionally compatible with the

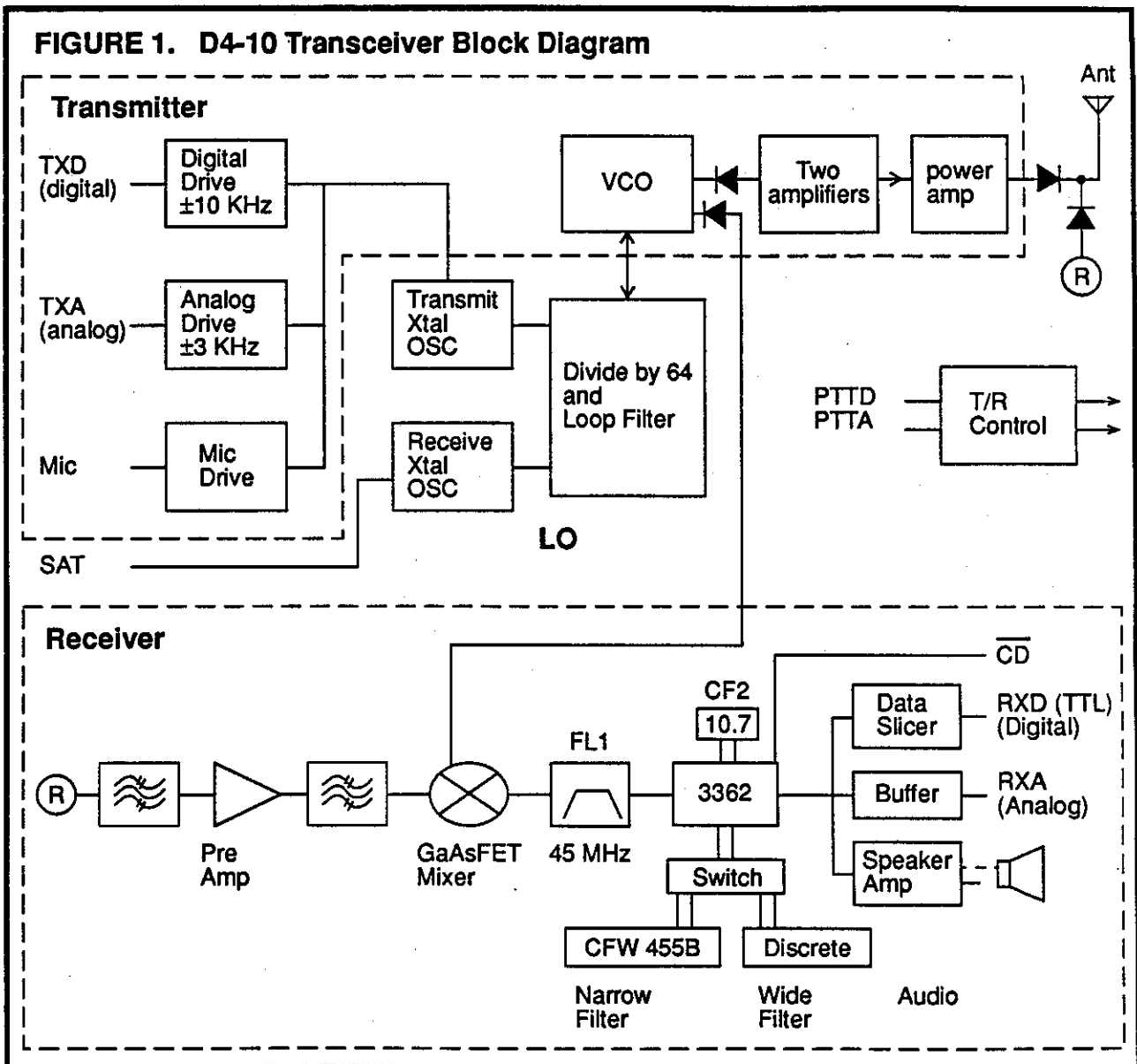

DVR 2-2 DB-9 data port. A TXA signal of 50 millivolts peak-to-peak (mv p-p) will generate an RF carrier with 3 KHz deviation. A TTL signal applied to the digital port will result in an RF carrier with 9.6 KHz deviation. Each port has its own push-to-transmit (PTT) control line.

Additional functions noted in the block diagram are the divide by 64 counter and loop filter, the transmit and receive crystal oscillators, TR control, data slicer and data buffer. We'll cover these details later. But first, let's look at desirable specifications.

D4-10 Transceiver Specifications

After designing, building, testing and then producing a 9600 baud capable 2-meter transceiver in mid-1990, the DVR 2-2¹, requests by other amateurs were quick to follow for a similar unit for 70-centimeters. Most suggested retaining the features of the DVR 2-2 but also increasing power and data rate capability. Most also felt that the 70-cm band was more appropriate for building a packet network, considering the crowding on 2-meters and the wide bandwidth channels allowed on 70-cm.

With those inputs in mind, a set of broad specifications emerged for a simple straightforward 70-cm transceiver for 1200, 9600 and 19,200 baud operation:

- two bandwidth modes of operation, narrow and wide
- two receiver modes of operation, terrestrial and satellite (AFC)
- two data ports
 - one DVR 2-2 plug compatible
 - one for 19,200 baud operation, TTL compatible
- fast TR switching
- a receiver derived carrier detect for optional use by TNC
- simple and straightforward, easy to work on
- and fun!

Since the unit may operate as a narrow-band data/voice radio or as a wide band, high speed data radio, two and perhaps three sets of specifications are really in order. The specs for VHF and UHF FM rigs imported today imply voice operation only. Some specs that are useful for modem users are simply left off. Of course, these rigs are used every day for packet and RTTY operation.

Typically, sensitivity is listed in so many microvolts for +12 dB SINAD. Audio output is listed in watts of power with a given distortion figure. No DC offset is listed, implying (and generally meaning) that unprocessed audio for high speed data purposes is not available at a rear connector; audio is AC coupled and available at the speaker for general use. This means the audio has been processed.

While Mic impedance is generally listed, Mic drive for a resulting amount of deviation is not. Most voice radio manufacturers include a matching Mic and therefore don't list Mic drive/deviation levels.

On bandwidth, the last IF filter of an FM rig generally sets selectivity characteristics. While bandwidth specs are not always listed, they are usually apparent by examining the schematic and noting the model number of the ceramic filter used. In surveying ten common rigs, we found eight using the Murata CFW series at 455 KHz.

FIGURE 2. D4-10 Specs

Receiver:	
item:	D4-10
freq coverage	428-436 MHz
freq control	crystal
temp-range	-10/60 °C
freq stability	±10 ppm
design	triple conv
front end:	
design	2 by 2
transistor	MRF571
first mixer	GaAsFET MRF966
spurious rej	
first IF	-60 dB
filter, FL1	45 MHz
2nd IF	discrete
filter, FL2	10.7 MHz
3rd IF	SFE10.7J
filter, FL3A	455 KHz
	discrete
filter, FL3B	60-KHz
	CFW455C
sensitivity:	
+12 dB SINAD	0.5 μV
	-113 dBm
10 ⁻³ BER	<1 μV
(note 1)	-107 dBm
main chip	MC3362
antenna switch	PINS
DC supply	+12 VDC
current	<200 ma
Transmitter:	
modulation	varactor
nom deviation	
wide band data	±9.6 KHz
TXD drive	TTL
nom deviation	
narrow band data	±3 KHz
TXA drive	50 mv p-p
max deviation	
voice operation	±4.5 KHz
spurious emission	-60 dB
Mic impedance	600 ohms
DC supply	+12 VDC
current	<2.5 amps
watts output	>10

Note 1: in conjunction with Data Engine and DE19K2 Modem.

Frequency stability is listed in KHz or in parts-per-million. For example, stability might be listed as ±10 ppm or as ±1.5 KHz. This is an important spec for high speed links attempting to use all of the bandwidth available. We'll cover this issue later.

With these comments in mind, our attempt to list a meaningful set of specs for the D4-10 for data use is shown in Figure 2. Items of particular importance for high speed data are frequency stability, the discrete 60 KHz filter (labeled FL3A), the BER sensitivity listing, and the data input levels required for a given deviation. Let's examine these in turn in light of the previous discussion.

Frequency Stability

First of all, frequency stability is more critical for data than for voice operation, particularly for high speed data. This is readily apparent by considering an ideal FM detector characteristic such as that shown in Figure 3. Let's trace the progress of the Frequency Shift Key (FSK) signal as it passes through the detector. In the ideal case the receiver is tuned exactly to the incoming signal; that is, at point 1 of the FSK signal, shown below the characteristic, we are centered on the detector characteristic. In other words, we are centered on the operational channel frequency.

As the signal shifts to a frequency f_1 our detector output shifts to a voltage value of $-A$. Then as the input signal shifts to a frequency of f_2 the output shifts to a voltage of $+A$. All is well.

However, if the receiver is not "on channel", but is, for example, 3 KHz low, then a distorted detector output occurs. As the signal shifts to an input frequency of f_1 , it could exceed the left side of the detector characteristic, i.e. it "falls off" the detector curve. This can happen as the receiver or transmitter in the link drifts off frequency (or is not tuned right to begin with!). If we are attempting

FIGURE 3. A Typical FM Detector Characteristic

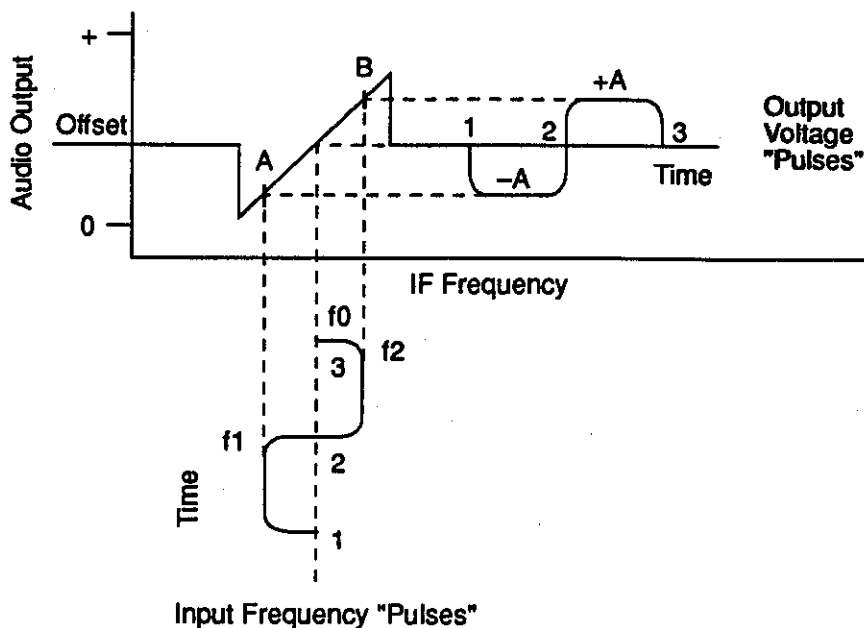

to use all the bandwidth available, our frequency swing will be near the detector edge anyway!

For example, let's assume that we choose a deviation of ± 3 KHz for a 9600 baud system and wish to change our packet link to 430.15 MHz from the usual 145.01. Further, let's assume that our transceiver has a stability of ± 10 ppm. If so, what is the result? We could be up frequency by 4300 cycles (10 ppm times 430) and the transmitter could be down 4300 cycles. Add the 3 KHz of deviation in one direction, and you can see that part of our signal would be 11.6 KHz off frequency! That's outside a normal channel, one using a standard IF bandwidth.

For those reasons, for either 9600 or 19,200 baud operation, and because 100 KHz channels are allowed on 70-cm, we picked a deviation of 9.6 KHz for the TTL port of the D4-10. The receiver can tolerate being somewhat more than 4300 cycles off frequency and still detect a signal swinging 9600 cycles each side of the operating frequency.

The Discrete 60 KHz Filter

First of all, our goal was 19,200 baud packet on the 70-cm channel. So, the bandwidth must be there to support the data rate. Second, the RF spectrum generated by a 19,200 BPS NRZI data stream is that of at most a 9600 cycle square wave. This wave would generate Bessel components at multiples of 9600 cycles either side of the carrier. The FCC regulations indicate that the energy outside the channel allowed must be down at least 26 dB. Hence, the modulator in the D4-10 must limit the transmitted spectrum by shaping the data stream (limiting higher-order Bessel components) and by keeping the maximum deviation reasonably narrow.

Within the D4-10 that is controlled by setting deviation for a TTL data input to 9600 cycles; that is, we deviate -9600 for a TTL zero and $+9600$ for a TTL one. Further, the pulses driving the varicap are scaled and shaped to eliminate harmonics above the 3rd. The resulting spectrum is better than -50 dBc at the 50 KHz band edges.

A4

D4-10

June 13, 1991

© Copyright 1991, Kantronics Co., Inc. All Rights Reserved.
Duplication of this manual without permission
of Kantronics Co., Inc. is prohibited.

This Leaves BER Sensitivity

Bit Error Rate (BER) testing methods have been described by Goode². In a similar manor, we have evaluated the D4-10 in concert with the Data Engine and a modified DE9600 modem, adapted for 19,200 use. The resulting sensitivity needed at 19,200 baud to achieve a BER of 0.1 percent was about 1 microvolt or -107 dBm.

With an expanded IF, it was expected that additional signal power would be required to achieve a BER of 1 in one-thousand, and indeed this was true. Second, the BER of a system is an overall measure, not just that of the modem itself. The $+12$ dB SINAD sensitivity of the receiver really sets the stage for the dBm level required to achieve a given BER. Simply, if the receiver is "hot", then the dBm level for a given BER could also be pretty low. We chose to put the $+12$ dB SINAD sensitivity level at about $0.5 \mu\text{V}$ or -113 dBm; hence, with added bandwidth the expected and resulting 0.1 percent BER level was -107 dBm.

Let's now take a look at the unique TTL port of the D4-10.

Some Details, the TTL Modulator and Demodulator Plus the Terrestrial/Satellite Option

First, the analog port of the D4-10 mimics the data port of the DVR 2-2 and is pin-for-pin compatible, so those details will not be covered here. However, the TTL data port and associated modulation and demodulation circuitry are new.

Figure 4 shows the inputs and outputs of the digital port and the associated circuitry for modulation and demodulation. The output of the MC3362 FM detector is buffered first by U3B, an op amp, and the signal is then fed to the data slicer for

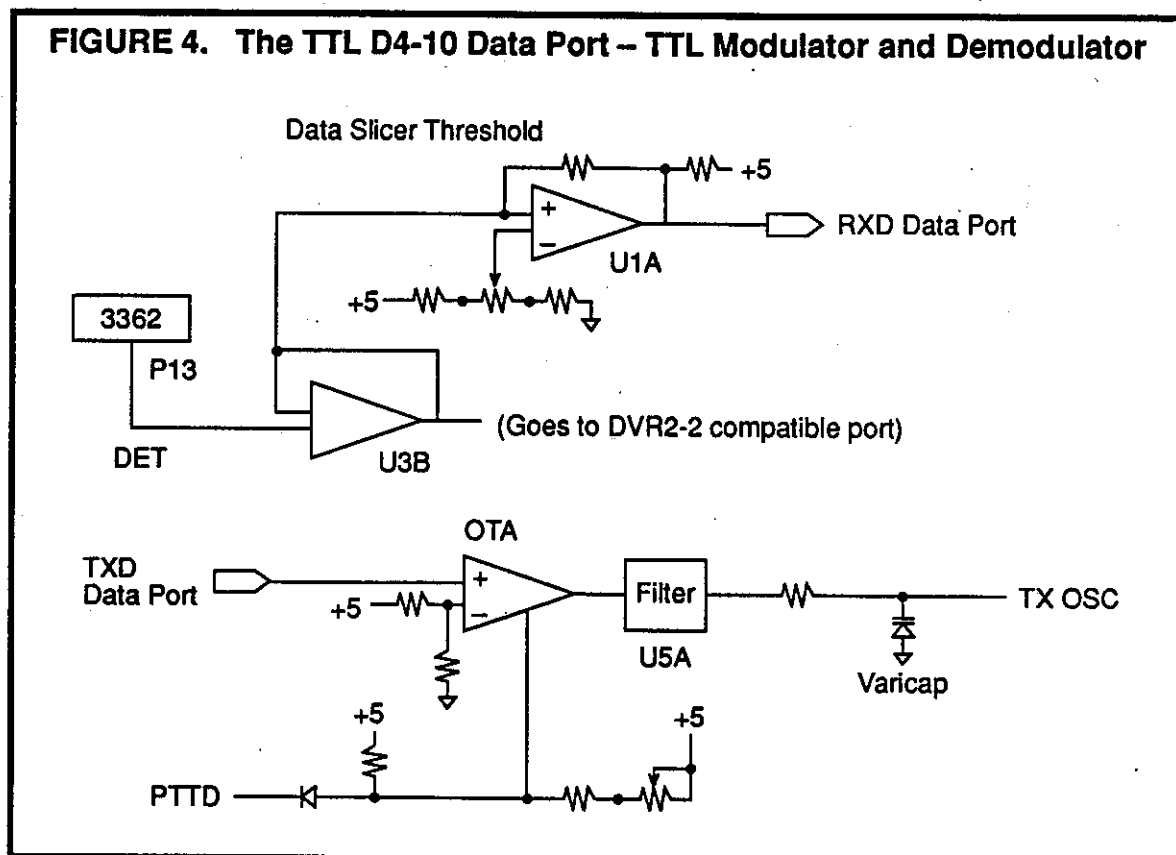

TTL restoration and also to the resistor divider for the analog port. The deviation is wide enough at 19,200 to allow for some frequency error, since the FSK signal emerging from the op amp buffer is fully 0.4 volts p-p, making a good slicer decision straight-forward. Part of the tuning procedure is to set the data slicer threshold at the midpoint of an "on frequency" data signal. One can use noise to set this threshold also, adjusting the threshold to the center of the detector noise.

The TTL transmit signals are converted by the CA3080 into current pulses which in turn modulate the varicap, pulling the crystal oscillator plus or minus 9600 cycles. The filter at U5A shapes the data prior to transmission.

For satellite work, a control input is available on the back panel of the D4-10 to pull the receiver crystal oscillator. By applying a DC control voltage, you'll be able to pull the receive frequency by controlling the varicap.

References

- (1) "DVR 2-2 Manual," Kantronics Inc, 1202 E 23rd St., Lawrence, KS, 66046.
- (2) "A Bit Error Rate Tester for Testing Digital Links," by Steve Goode, K9NG, Sixth ARRL Amateur Radio Computer Networking Conference, Redondo Beach, CA, 1987, pp 62,67.

**Kantronics D4-10
Errata Sheet**

The following information became available after printing the manual for the D4-10, 70 cm data transceiver. Please make the following corrections to your manual.

On Page 6 (Installation) add the following note to the bottom of the page:

NOTE: Shielded cable must be used for all connections to the Analog port and the TTL port of the D4-10 radio. Failure to use shielded cable may render the Part 15, Sub-Part J FCC certification invalid.

On page 16 (Disassembly Instructions) add the following:

1a. Remove the screw located near the center of the front panel.

On page 16 (Assembly Instructions) add the following:

5. Install the screw securing the PC board to the front panel. Failure to install this screw will render the Part 15, Sub-Part J FCC certification invalid.